

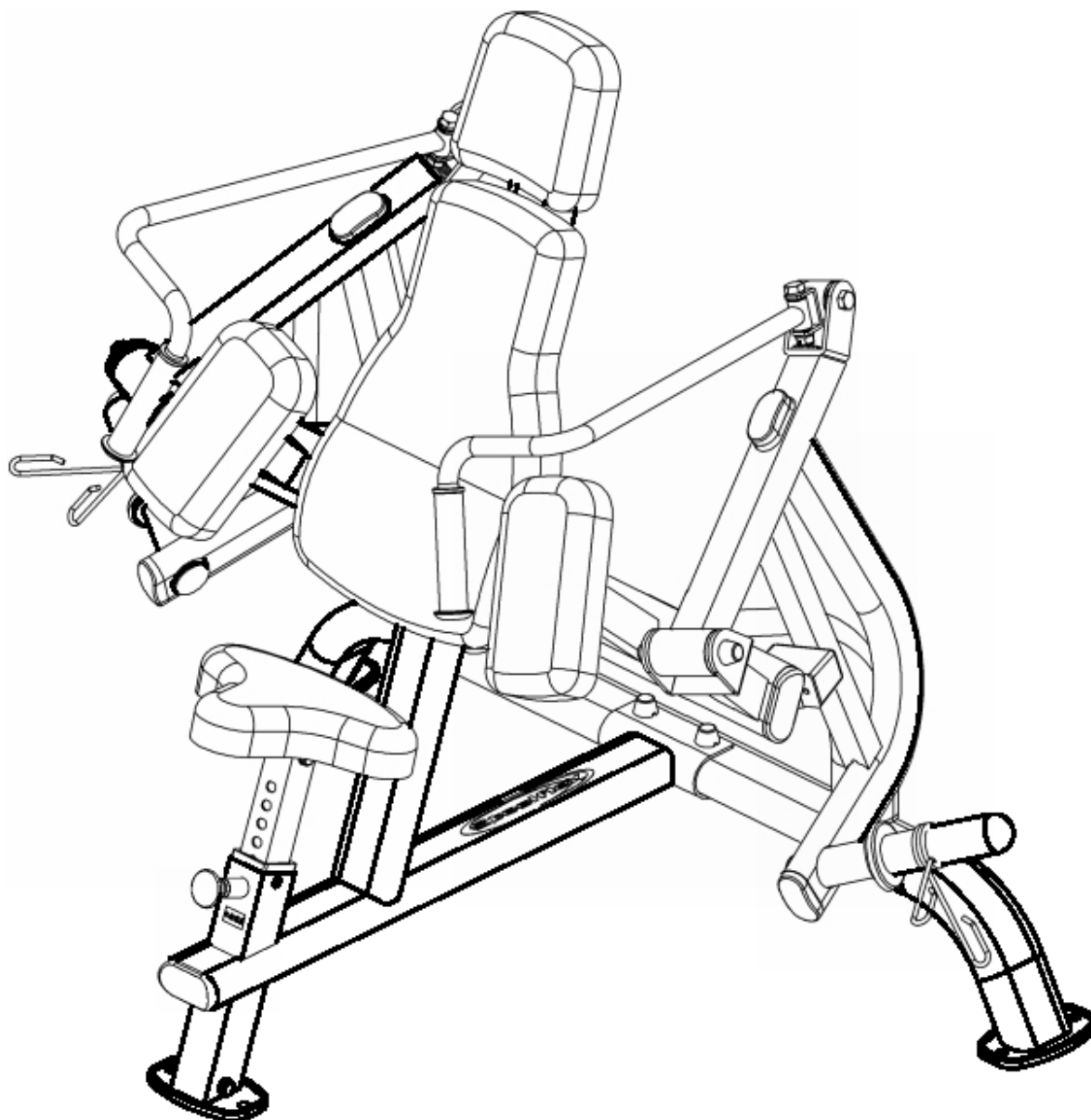

UŽIVATELSKÝ MANUÁL – CZ
IN 5100 Posilovací stanice Steelflex PLTE - triceps



Spojovací materiál

(nákres ve skutečné velikosti)

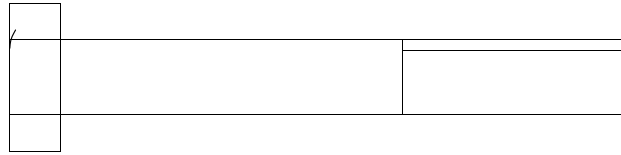
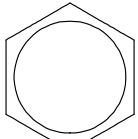

A1. M10x75 Šestihranný šroub...1 kus (Předmonotovaný)

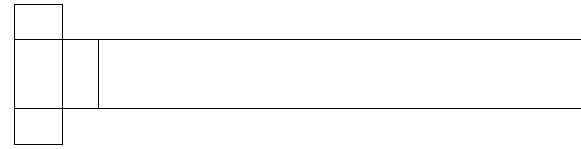
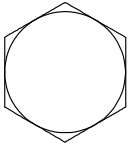

A2. M10x70 Šestihranný šroub...2 kusy

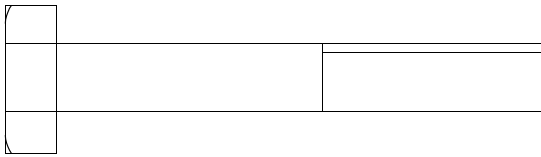
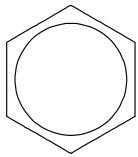

A3. M10x65 Šestihranný šroub (částečný závit) ...7 kusů

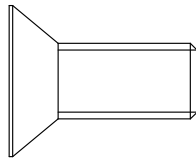
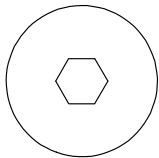

A4. M10x25 Kuželový šroub (celý závit)...2 kusy (Předmonotovaný)

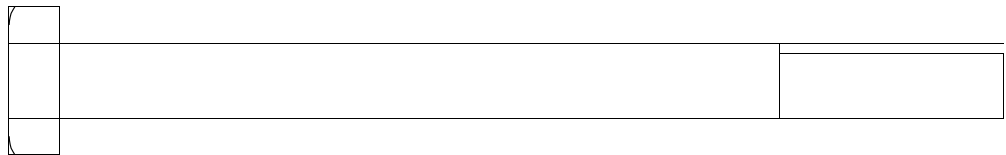
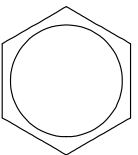

A5. M10x125 Šestihranný šroub (částečný závit) ...2 kusy

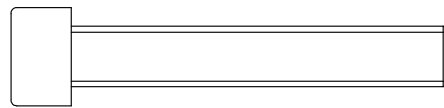
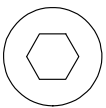

A6. M8x50 Imbusový šroub (celý závit)...4 kusy

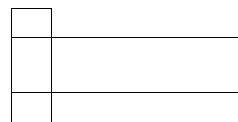
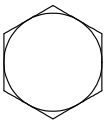

A7. M8x25 Šestihranný šroub (celý závit)...13 kusů

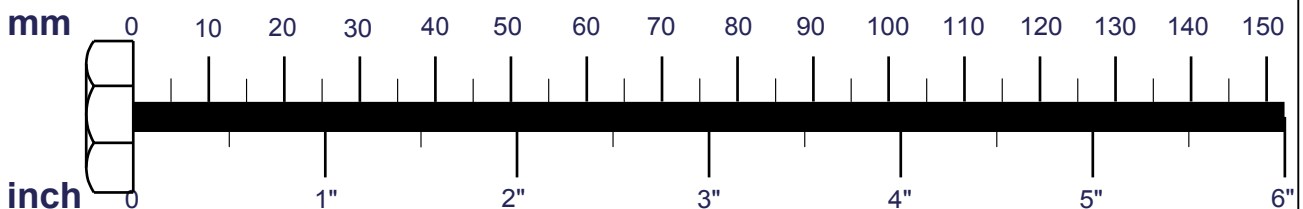

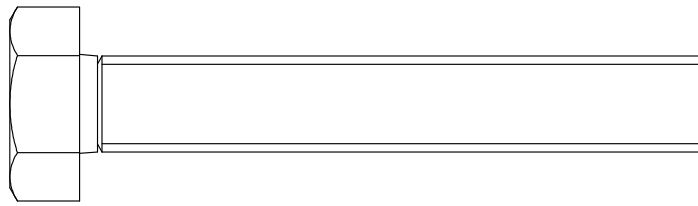
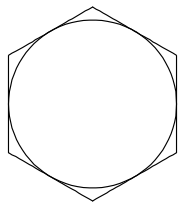

A8. 1/2" X 3 1/4" Šestihranný šroub ...2 kusy

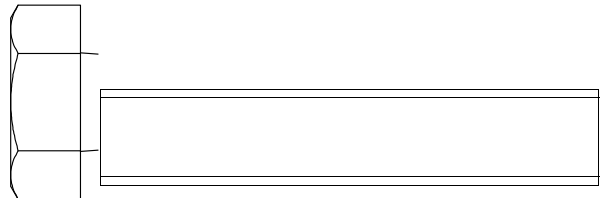
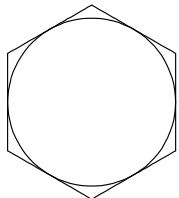

A9. 1/2" X 2 3/4" Šestihranný šroub ...2 kusy
(Přemontvaný)

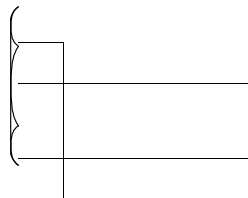
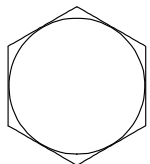

A10. M12 X 25 Šestihranný šroub ...2 kusy

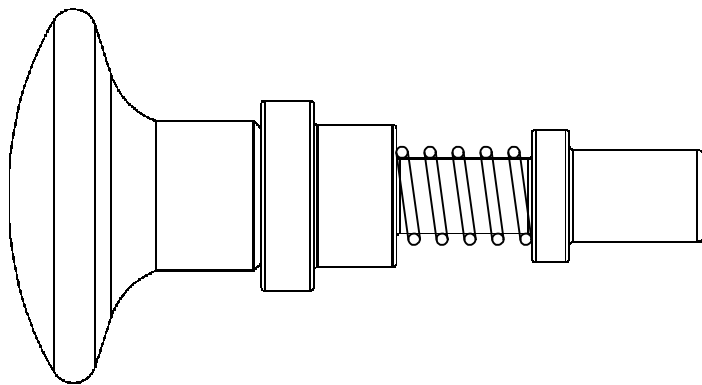

A11. 1/2"x38L Zajišťovací kolík (8250-065G)...1 kus (Přemontvaný)

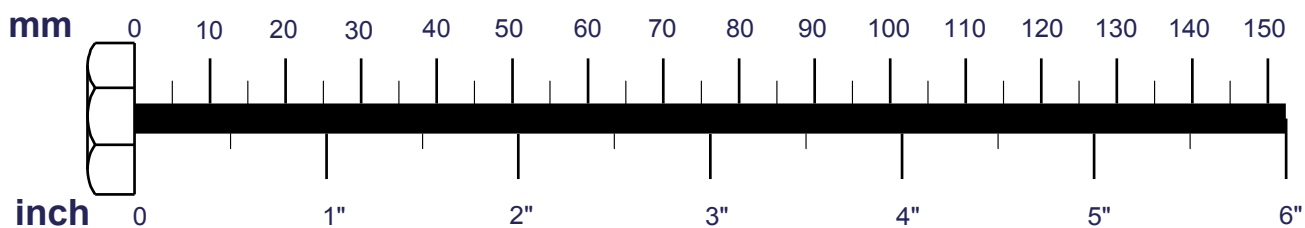

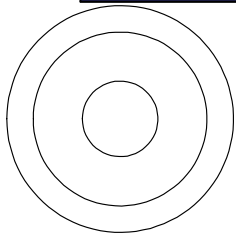

C1. Talířová podložka M10 (Ø30)...16 kusů

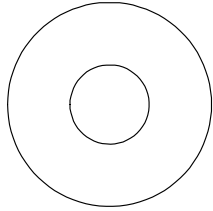

C2. Podložka M10 (Ø27)...2 kusy

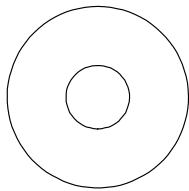

C3. Podložka M8 (Ø24)...13 kusů

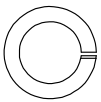

C4. Pérová podložka M8 ...13 kusů

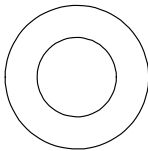

C5. Podložka M10 (Ø19)...2 kusy (Předmonotvaná)

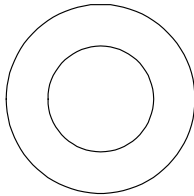

C6. Podložka 1/2" (Ø25)...4 kusy (Předmonotvaný)

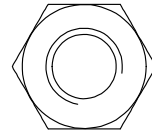

B1. Samojistící matice M10 10 kusů (Předmonotvaný)

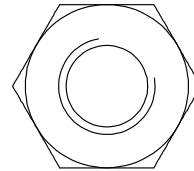
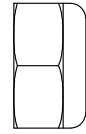

B2. Samojistící matice 1/2" 4 kusy (Předmonotvaná)

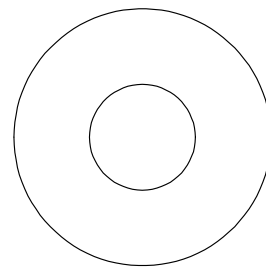
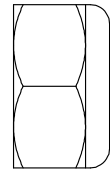

C7. Podložka M12 (Ø34)...2 kusy

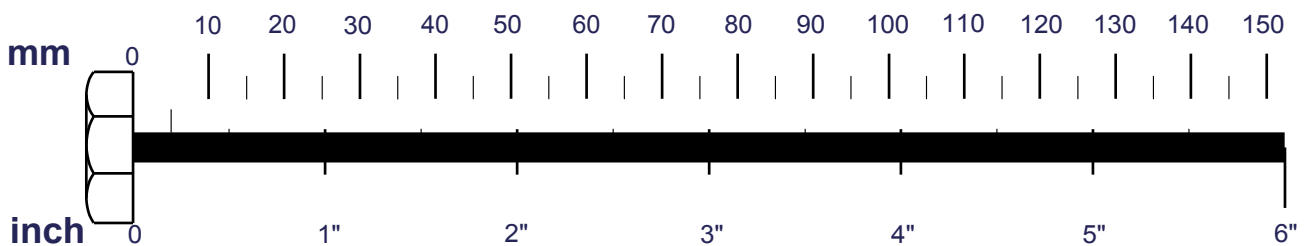

DÍLY

A [1 kus]

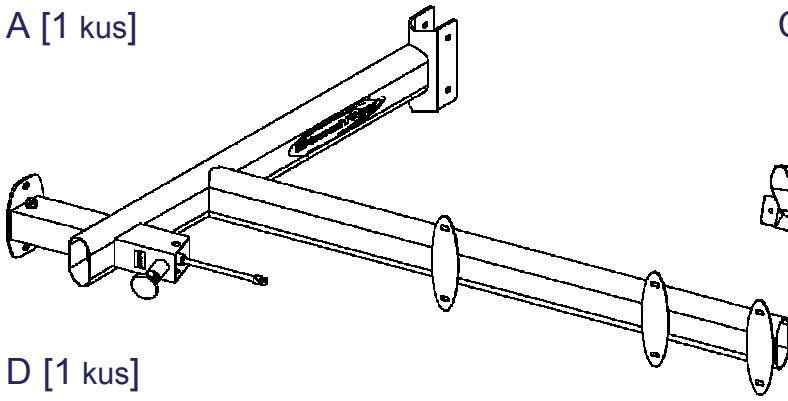

C [1 kus]

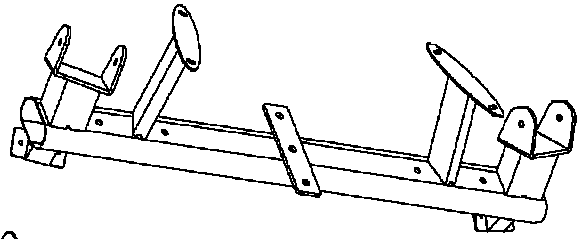

D [1 kus]

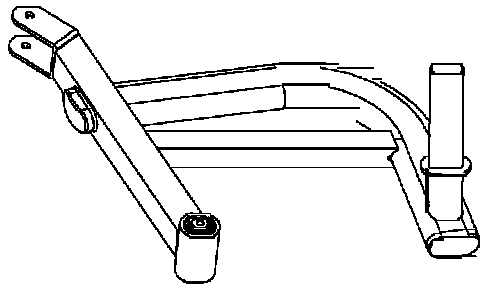

E [1 kus]

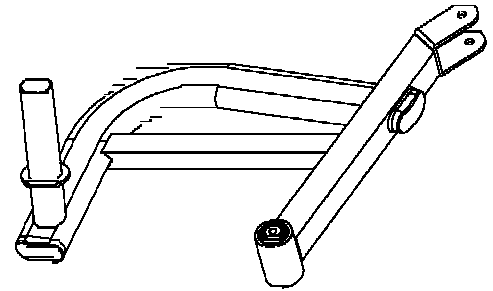

F [1 kus]

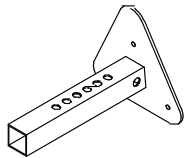

H [1 kus]

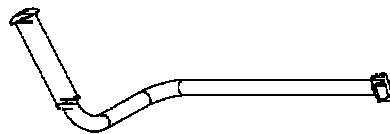

HR [1 kus]

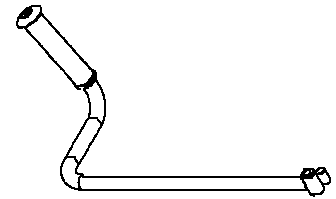

I [1 kus]

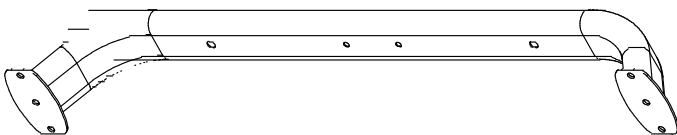

J [2 kusy]



K [2 kusy]

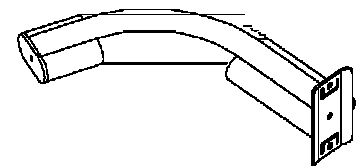

M [1 kus]
9111072

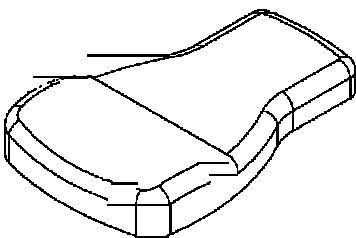

N [1 kus]
9144016

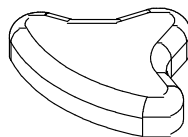

P [1 kus]
9131025

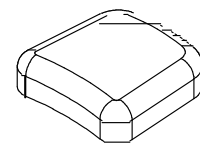

Q [2 kusy]
9131037

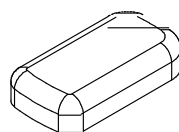

DÍLY

D1. Koncová krytka (8130-131) předmontováno	[2 kusy]
D2. Vymezovací vložka (8120-084) předmontováno	[4 kusy]
D3. Vymezovací vložka (8530-009)	[2 kusy]
D4. Koncová krytka Ø50 (9211-020)	[2 kusy]
D5. Kulatá koncová krytka Ø50 (9211-074)	[2 kusy]
D6. Koncová krytka 40x80 (9211-113) předmontováno	[4 kusy]
D7. Koncová krytka 50x100 (9211-114)	[4 kusy]
D8. Gumová podložka (9310-016)	[2 kusy]
D9. Gumová podkládací destička (9310-076)	[3 kusy]
D10. Gumový doraz (9310-077)	[2 kusy]
D11. Bezpečnostní objímka (OC-06)	[2 kusy]
D12. Krytka šroubu (9212-026)	[16 kusů]
D13. Podložka (8520-001) předmontováno	[4 kusy]
D14. Gumová podložka 38X38 (9310-001)	[2 kusy]
D15. Ložisko (8510-003) předmontováno	[4 kusy]
D16. Ložisko (8510-020) předmontováno	[4 kusy]
D17. Vymezovací vložka (8120-082) předmontováno	[4 kusy]
D18. Pěnový grip (9162-118) předmontováno	[2 kusy]
D19. Nylonová vložka 60X60 (9211-047)	[1 kus]
D20. Hydraulická tyč k nastavení sedla (8830-023) předmontováno	[1 kus]

D1



D2



D3



D4



D5



D6



D7



D8

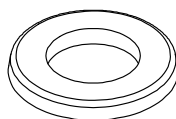

D9

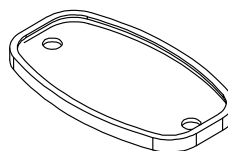

D10

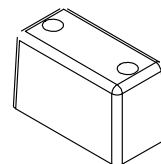

D11

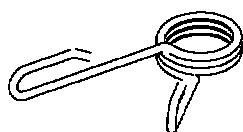

D12



D13



D14

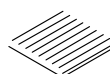

D15



D16



D17



D18

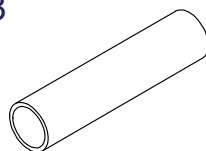

D19

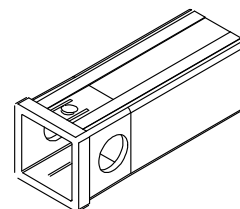

D20



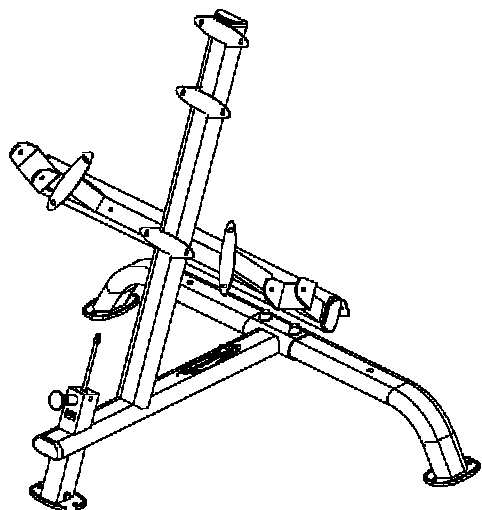

Krok 1: dokončená montáž

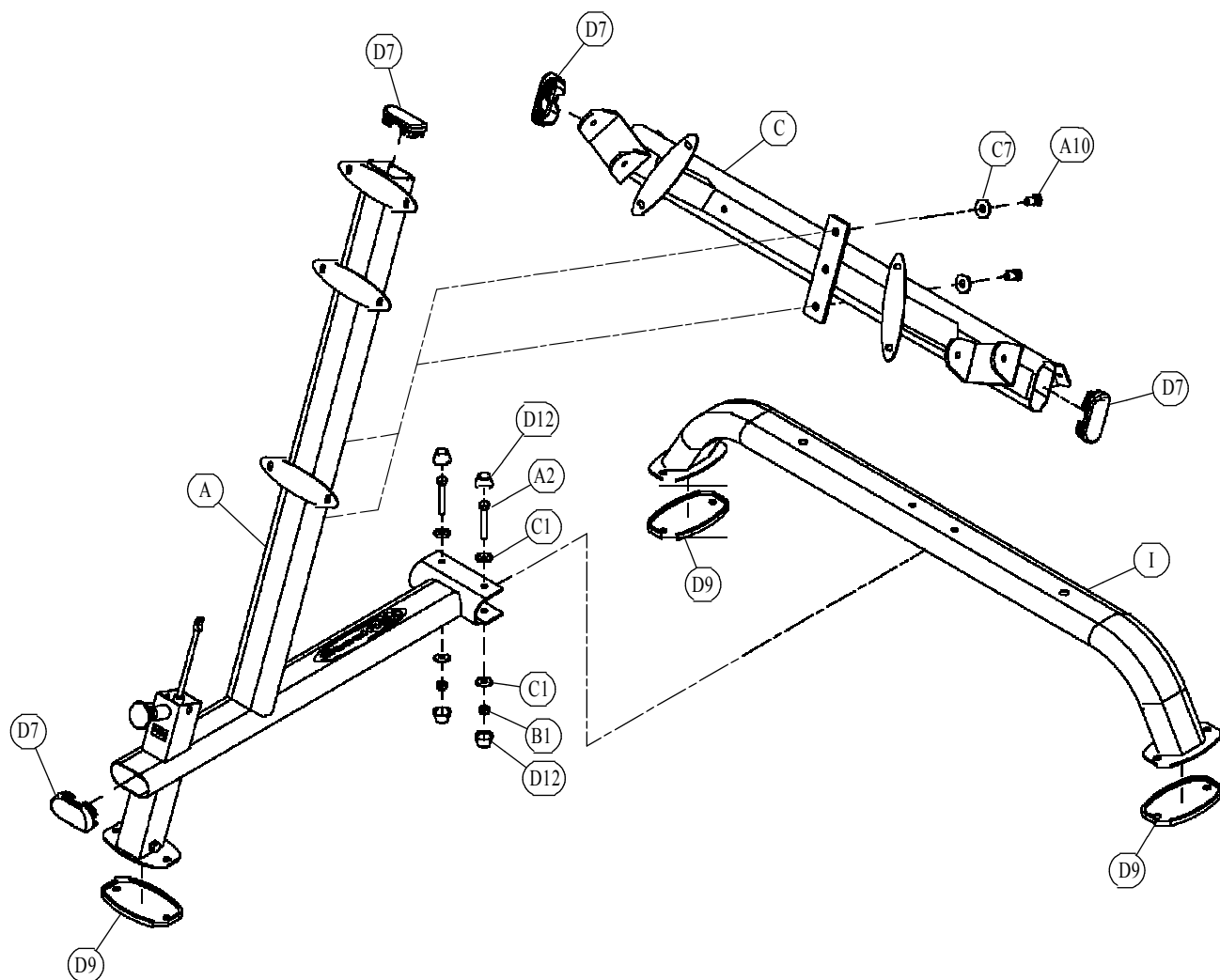

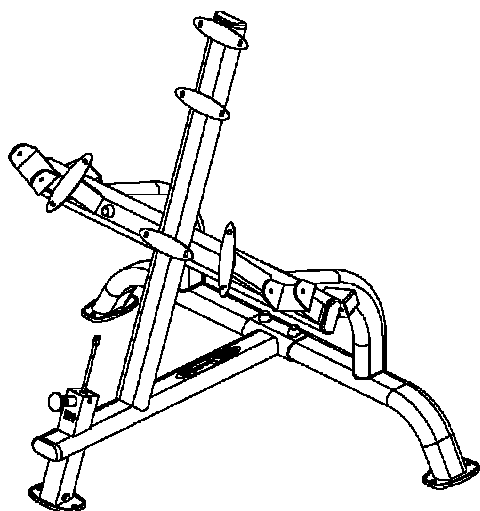

Krok 2: dokončená montáž

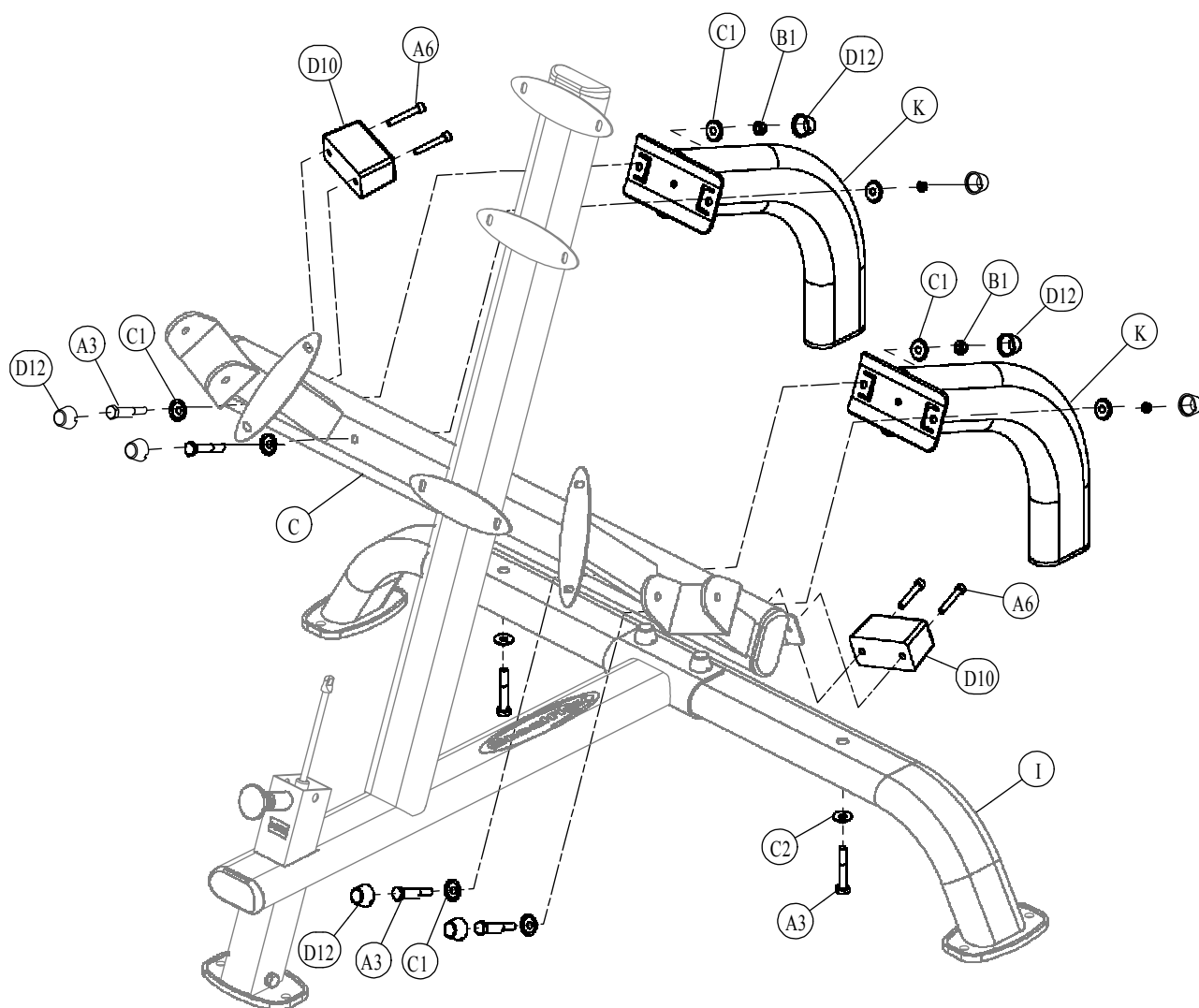

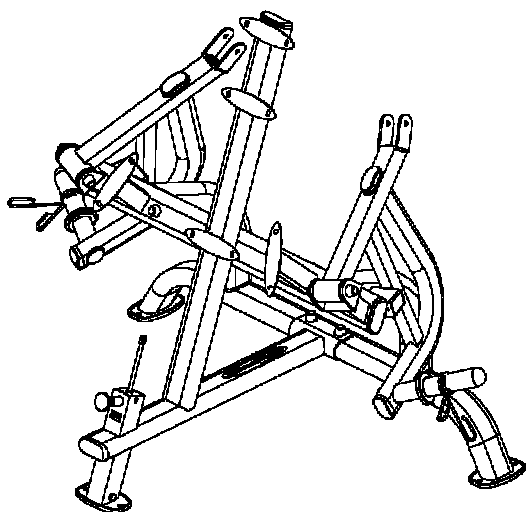

Krok 3: dokončená montáž

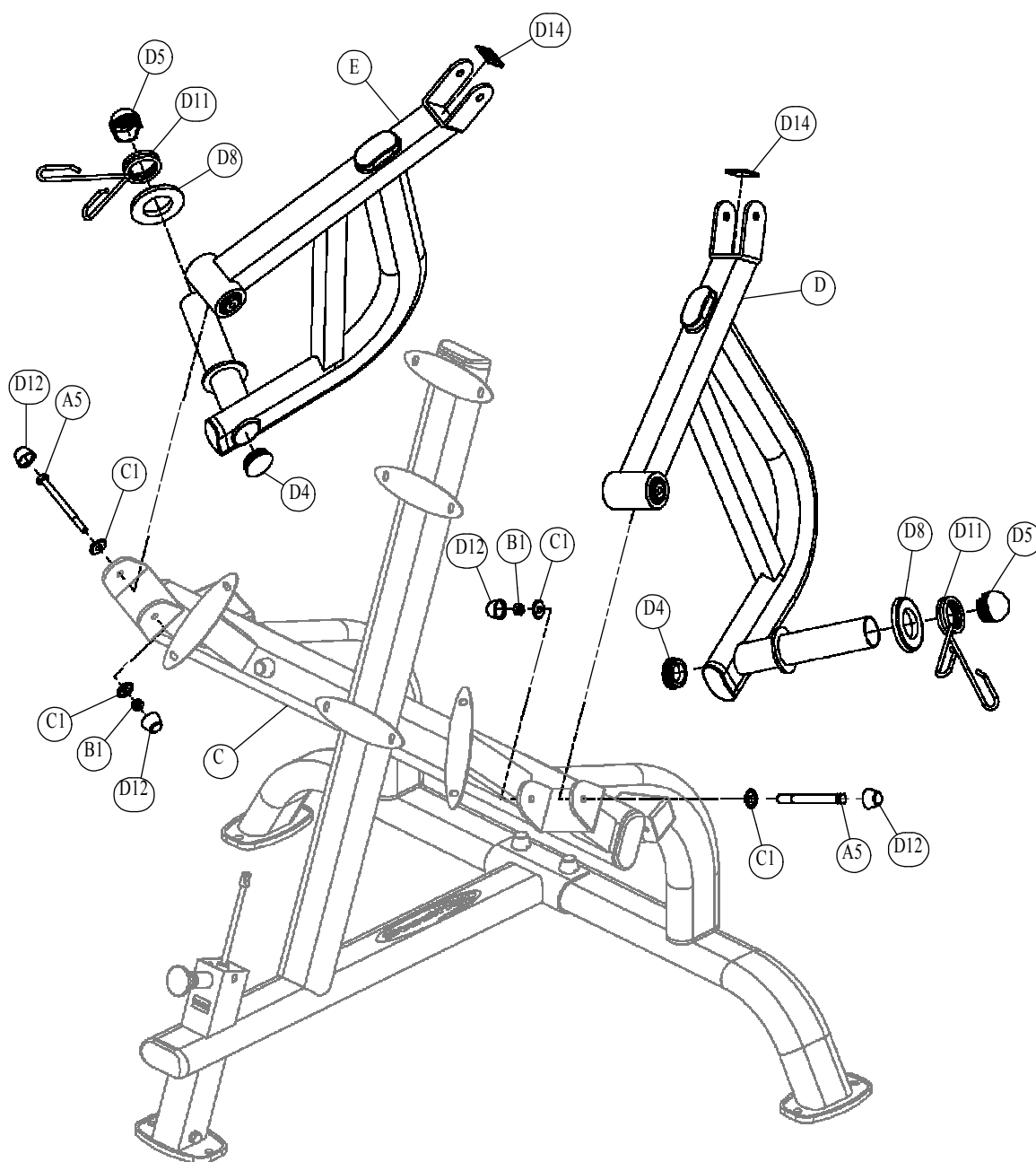

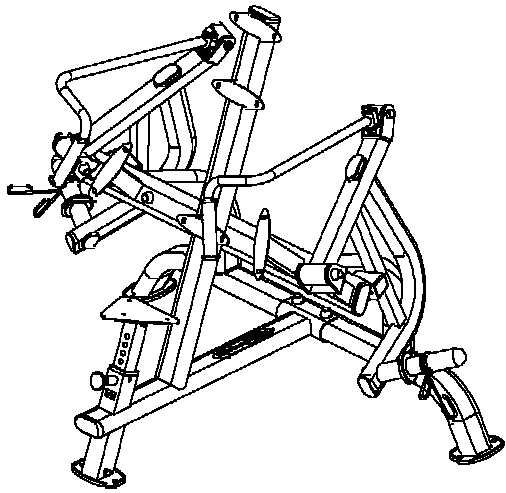

Krok 4: dokončená montáž

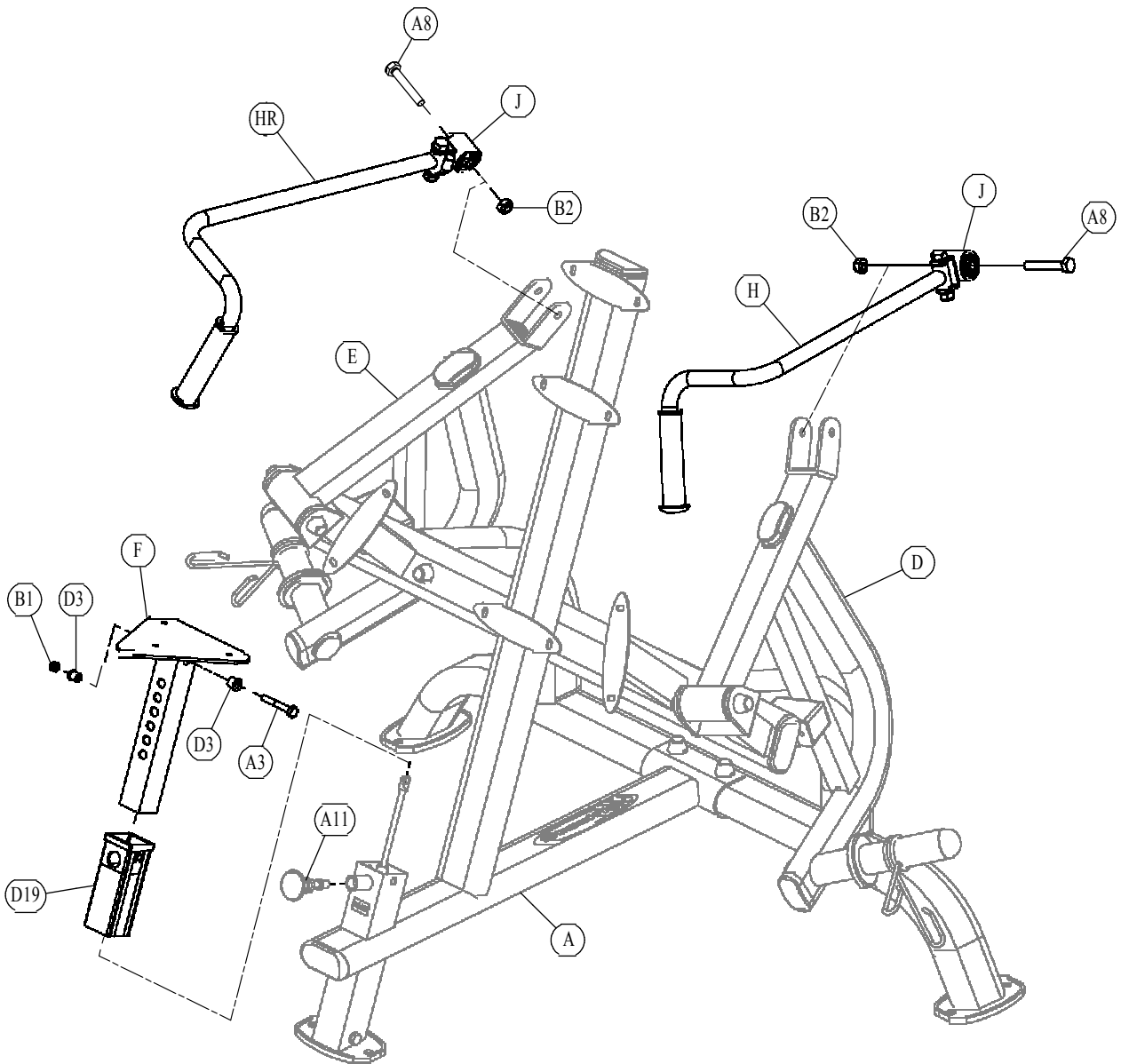

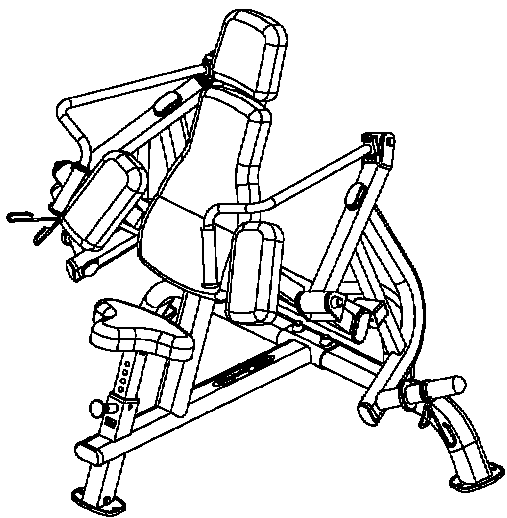

Krok 5: dokončená montáž

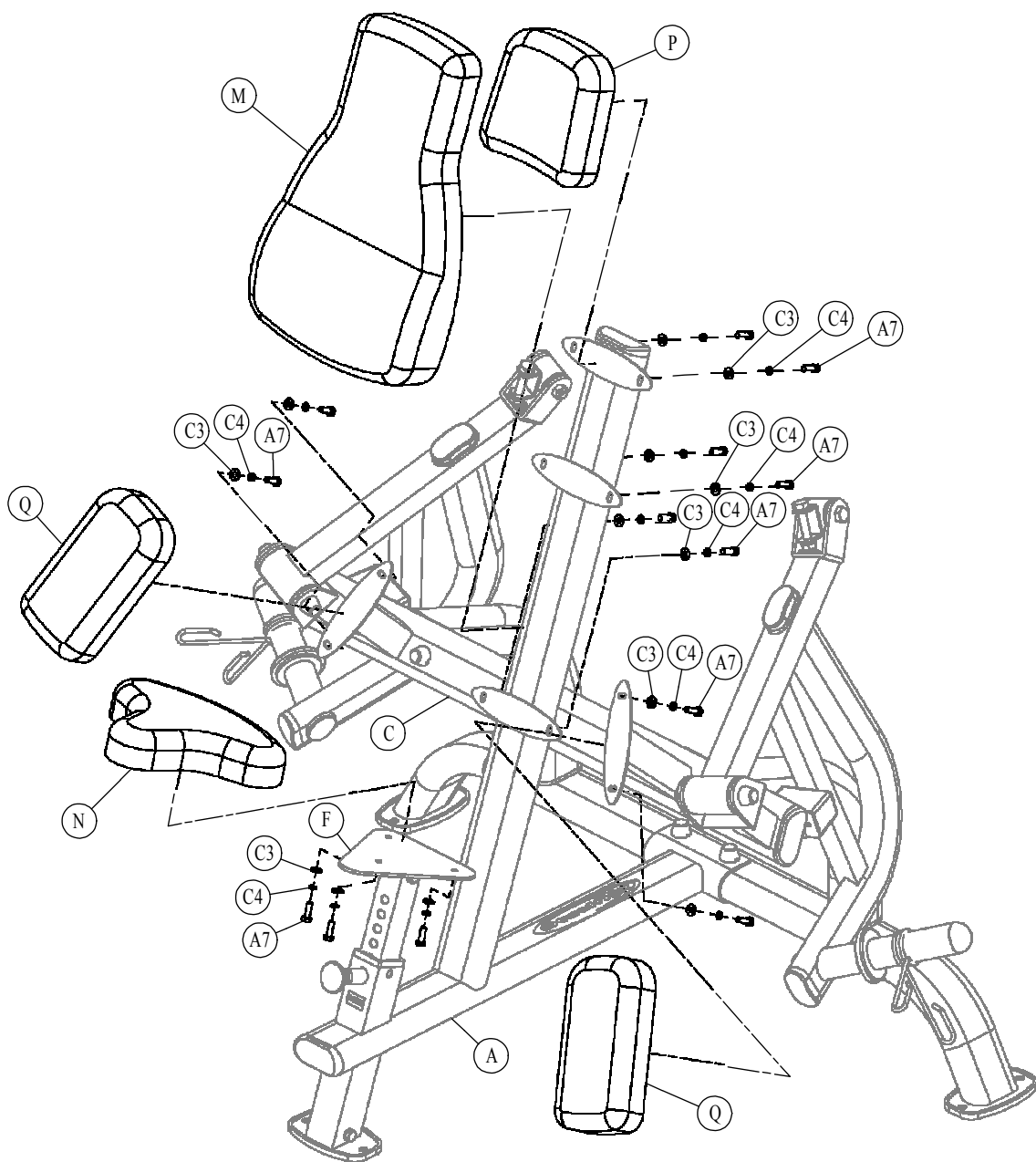

PLTE SCHÉMA

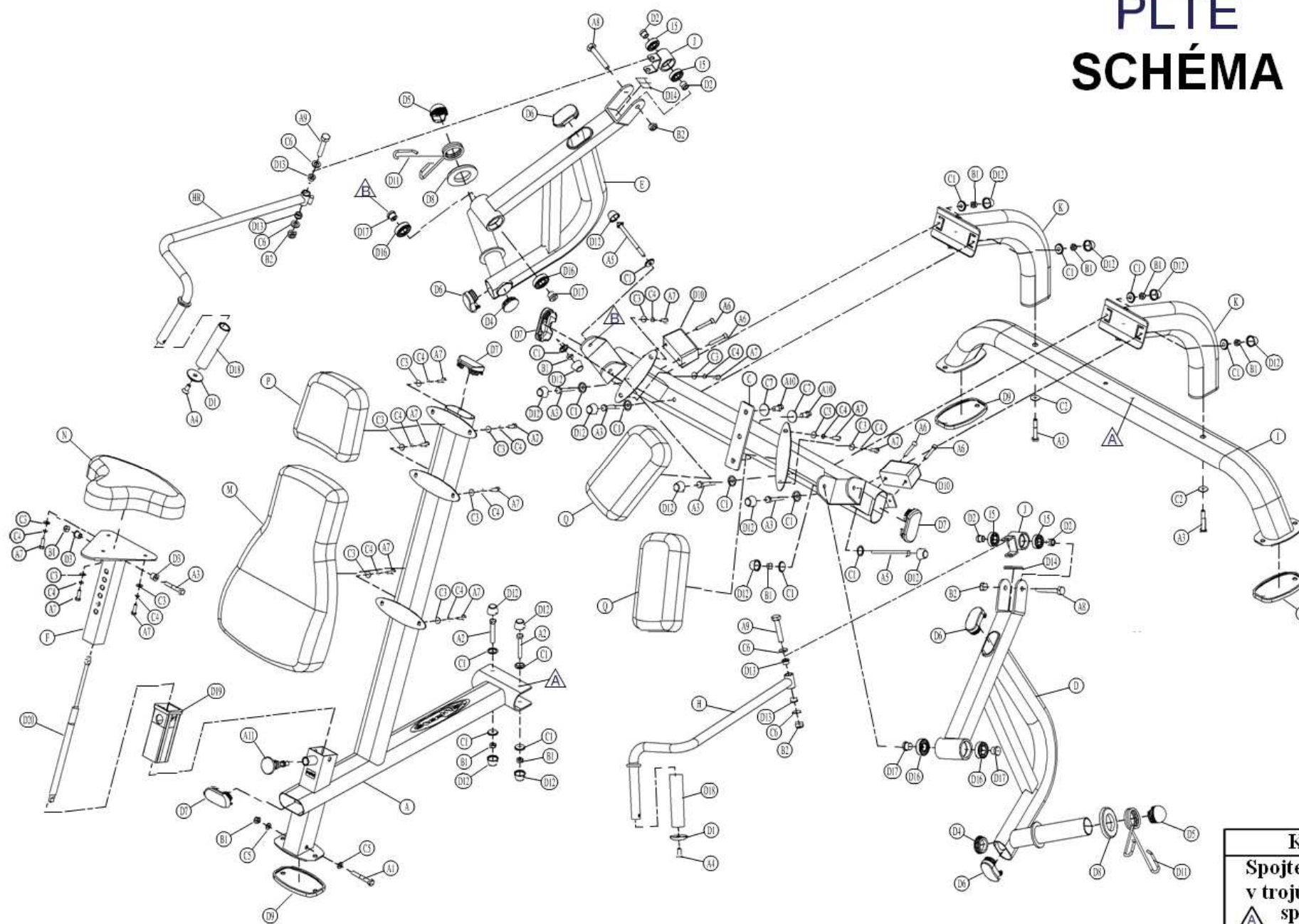

KLÍČ			
Spojte písmena v trojúhelnících			
▲	spojte s	▲	
▲	spojte s	▲	